



Beautiful bathrooms deserve
beautiful water heaters too.



5 STAR ENERGY RATING
ON SELECTED MODELS



GAS | ELECTRIC | INSTANT | HEAT PUMP



Conceived back in 1960, the Jaquar Group has been built on the platform of the highest quality standards, aesthetics and the intent of providing world-class products. Today, the Jaquar Group caters to luxury, premium and value bathroom segments with Artize, Jaquar & Essco brands, respectively, for residential and commercial sectors across the globe.



JAQUAR GROUP GLOBAL HEADQUARTERS

LEED Platinum Certified by USGBC. Net Zero Energy building spread over 48,000 sq. m.

A Artize

craftsmanship in water

A tribute to the fine traditions of exquisite craftsmanship and precision where design, technology and expertise combine to deliver a masterpiece. Artize products are crafted for luxurious bath spaces. Perfect harmony is the very essence of Artize-together as coordinates or even as individual pieces. Artize's exquisite craftsmanship is so stunning that it can inspire the design principles of not just your bath spaces but of your entire living spaces.



The oldest brand from India's most trusted corporate in the bathware segment, Essco has been in existence for 5 decades. A value brand that added a whole new chapter to the country's bath fittings industry by ushering in the era of the organised bath market, Essco has been supporting affordable and sustainable housing in India. Its range of quality products are not only priced reasonably, but also offer a 10-year warranty and excellent customer service.

Essco has been standing tall in the Indian bath fittings industry since 1960 by delivering great performance at a low cost. And enabling Indian consumers to live a better quality of life through good sanitation and affordable housing.



Created for the premium segment, the Jaquar brand offers the Indian consumer easy access to the finest choices in bathing products. India's most trusted bath brand, Jaquar is an undisputed market leader because of its quality that is backed by unmatched customer service - available nationwide, with a single number. A global Superbrand, Jaquar's wide range of products combine beautifully designed aesthetics with the highest build quality to ensure that they can withstand tough Indian usage conditions. Customer confidence in the brand is further strengthened with the 10-year warranty and industry-leading customer care. A Complete Bathroom Solutions brand, Jaquar is a one-window solution brand for anyone seeking to build a beautiful bathroom.



Jaquar Lighting gives you complete lighting solutions - for residential, commercial and outdoor use. Our extensive range lets you choose for varied budgets without compromising on quality and reliability. They are designed to complement and coordinate the most exclusive interior and exterior lifestyles and decors, from classic to contemporary. The house of Jaquar has the legacy of excellence that has been manifested time and again through its brand of bath fittings; Jaquar Lighting is no exception. Every lighting product reflects Jaquar's impeccable record of superlative quality and painstaking attention to detail.

CONTENTS

Why Jaquar Water Heaters	3
How to select a water heater on the basis of capacity	5
Choose the right water heater for your needs	6
Insta Prime (Digital)	8
Insta	10
Insta Gas	12
Erica Vertical (Manual)	14
Erica Vertical (Digital)	16
Elena Prime Vertical (Manual)	18
Elena Vertical (Manual)	20
Elena+ (Manual)	22
Elena Horizontal (Manual)	24
Alexa Plus	26
Alexa	28
Versa Vertical (Manual)	30
Versa Horizontal (Manual)	32
Versa Horizontal (Digital)	34
Verna	36
Integra Monobloc Heat Pump	38
Integra Split Heat Pump	40
Integra-X Split Heat Pump	42

Why Jaquar Water Heaters

Water heaters that give you more.

To ensure that they are worthy of the trust that is placed by customers in every Jaquar product, a whole range of safety, longevity and energy efficiency features have been built in to these water heaters:

1) MORE SAFETY

- Double Safety Thermostat – dual overheating control mechanism cuts off power automatically even if primary cut off fails
- Multi-function Safety Valve – discharges water and acts as a non-return valve if pressure or temperature exceed preset limits



Multi Function
Safety Valve



Double Safety
Thermostat



Earth Leakage
Circuit Breaker

2) MORE LIFE

- Superior Quality Glass-lined Inner Tank – prevents rust, corrosion and prolongs the life of the inner tank
- Single/Dual Glass-coated Incoloy Heating Elements – made of high quality steel for quicker heating and to prevent scale formation



High Quality
Glass Lined
Heating Element



3) MORE SAVINGS

- High Density Insulation – CFC-free PUF insulation, with added thickness to minimise heat loss and maximise energy savings
- Cathodic Protection – a sacrificial Magnesium Anode protects and saves the tank from electrochemical reactions during water heating



Energy Saving
High Density
PUF Insulation



Cathodic
Protection

4) ATTRACTIVE DIGITAL FEATURES

- Cordless Remote: Wireless remote control for operational ease
- Full Digital Display
- On/Off Timer
- Clock Temperature Setting



Cordless
Remote



Digital Controls
and Display

*Available in Alexa Plus 20L, Alexa 30L, Elena (Digital) 15/25L, Erica (Digital) 15/25L, Insta Prime, Versa Digital 40L-100L & Heat Pump 200L - 500L

5) TRUST OF JAQUAR

- Quality sets Jaquar apart. The high standards of our products have cemented our reputation as the most valued premium brand in the bathing industry

6) UNMATCHED CUSTOMER SERVICE

- Jaquar Water Heaters come with a warranty along with service back-up. Jaquar also offers a Preventive Maintenance Service for hassle-free bathrooms



How to select your water heater on the basis of capacity

INSTANT GAS

Capacity (in litres)			
Model	6	10	16
Insta Gas (LPG)	✓	✓	
Insta Gas (PNG)	✓	✓	✓

ELECTRIC

Capacity (in litres)														
Model	6	10	15	20	25	30	40	60	80	100	200	300	400	500
Elena (Manual)	✓	✓	✓		✓									
Erica (Manual)	✓	✓	✓		✓									
Erica (Digital)			✓		✓									
Elena* (Manual)	✓	✓												
Elena (Horizontal)			✓		✓									
Elena Prime	✓	✓	✓		✓									
Versa (Vertical)							✓	✓	✓	✓				
Versa (Horizontal)							✓	✓	✓	✓				
Versa (Digital)							✓	✓	✓	✓				
Alexa Plus				✓										
Alexa						✓								
Verna (Floor Mounted)											✓	✓	✓	✓

























INSTANT

Capacity				
Model	1 LITRE	3 LITRE		
Insta	3 kW/4.5 kW	3 kW/4.5 kW		
Insta Prime (Tankless) 3 phase	9 kW	12 kW	18 kW	24 kW
Insta Prime (Tankless) Single phase	9 kW	-	-	-

HEAT PUMP

































Capacity (in litres)				
Model	200	300	400	500
Integra Monobloc	✓	✓		
Integra Split		✓	✓	✓
Integra-X Split	✓	✓	✓	✓

Choose the right water heater for your needs:

MODEL	INSTA PRIME	INSTA/ INSTA GAS	ERICA/ELENA		ELENA (Horizontal Model)	
[LITRES]	1 & 3	1 & 3	6 & 10	15 & 25	15	25
INSTALLATION	 WALL MOUNTED	 WALL MOUNTED	 WALL MOUNTED	 WALL MOUNTED	 WALL MOUNTED	 WALL MOUNTED
USAGE	 SHOWER	 BUCKET BATH/ KITCHEN	 BUCKET BATH/ KITCHEN	 SHOWER	 BUCKET BATH	 SHOWER
FAMILY SIZE	 LARGE FAMILY	 SMALL FAMILY	 SMALL FAMILY	 SMALL FAMILY	 SMALL FAMILY	 SMALL FAMILY
REMOTE	 NO REMOTE	 NO REMOTE	 NO REMOTE	 CORDLESS REMOTE	 NO REMOTE	 NO REMOTE





ALEXA PLUS / ALEXA		VERSA (Horizontal/Vertical Model)				VERNA (Floor Mounted)	INTEGRA/ INTEGRA-X (Floor Mounted)
20	30	40	60	80	100	200, 300 400 & 500	200, 300 400 & 500
 WALL MOUNTED	 WALL MOUNTED	 WALL MOUNTED	 WALL MOUNTED	 WALL MOUNTED	 WALL MOUNTED	 FLOOR MOUNTED	 FLOOR MOUNTED
 SHOWER	 SHOWER	 SHOWER	 SHOWER PANELS	 BATHTUB	 WHIRLPOOL	 WHIRLPOOL/ SPA	 WHIRLPOOL/ SPA
 SMALL FAMILY	 SMALL FAMILY	 LARGE FAMILY	 LARGE FAMILY	 LARGE FAMILY	 LARGE FAMILY	 LARGE FAMILY/ MULTIPLE BATHROOMS	 LARGE FAMILY/ MULTIPLE BATHROOMS
 WITH REMOTE	 WITH REMOTE	 NO REMOTE	 NO REMOTE	 NO REMOTE	 NO REMOTE	 NO REMOTE	 WITH REMOTE

*Conditions apply. Features available on select models.

INSTA PRIME

(Digital)



Available in 9*/12/18/24 kW
Ideal for unlimited water supply during shower bath

*9kW is available in single phase also

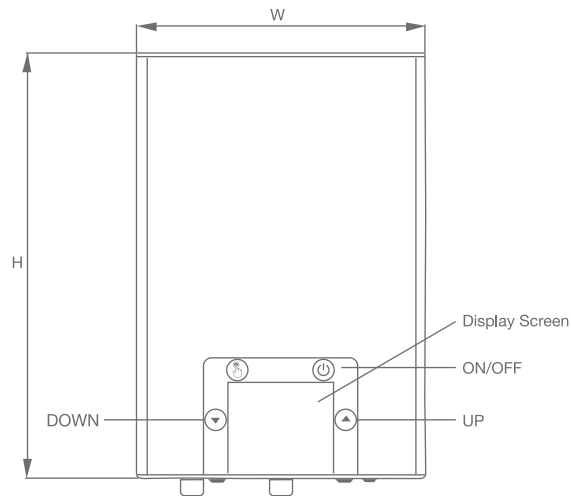

Product Specifications

Details	Insta Prime (Digital) 3 Phase			Insta Prime (Digital) Single Phase		
Rated Wattage	9/12/18/24 kW			9 kW		
Voltage / Frequency (V/Hz)	400V/50Hz			230V/50Hz		
Temperature Range	25°C to 70°C			30°C to 55°C		
Working Pressure (Mpa)	0.8			0.6		
Inlet / Outlet Connection (Inch)	1/2			1/2		
Warranty	3 Years on heating element 1 Year on other components			3 Years on heating element 1 Year on other components		
Product Dimensions (in mm)	W	H	D	W	H	D
	260	385	90	215	360	60

Recommended for: Kitchen / Bucket Baths

INSTA



Available in 1/3 litres
The perfect instant water heater for kitchens

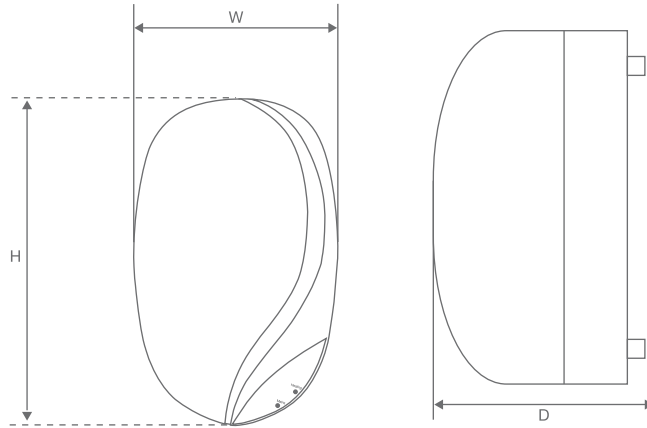

Product Specifications

Details	Insta
Volume (L)	1/3
Rated Wattage	3/4.5 kW
Voltage / Frequency (V/Hz)	230V/50Hz
Temperature Range	25°C to 75°C
Working Pressure (Mpa)	6.5 Bar
Inlet / Outlet Connection (Inch)	1/2
Inner Container Material	Stainless Steel
Warranty	5 Years on Tank 2 Years on Heating Element 2 Years on Other Parts
Product Dimensions (in mm)	W H D
	1 Litre 200 330 150
	3 Litres 230 370 200

Recommended for: Kitchen / Bucket Baths

INSTA GAS



Available in 6/10/16 litres
The perfect instant water heater for small families

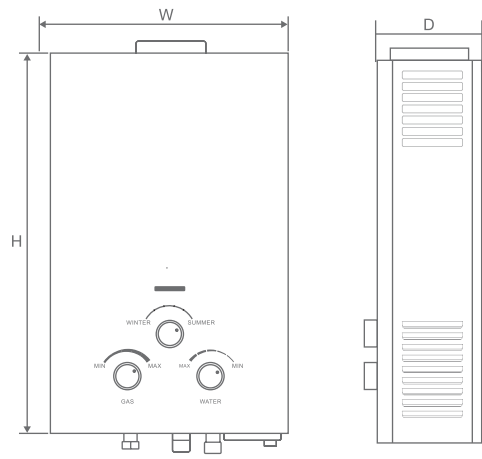

Product Specifications

Details	Instant Gas			Instant Gas				
Volume (L)	06/10			16				
Rated Gas Supply Pressure (Pa)	NG - 2000			NG - 2000				
	LPG - 2800			-				
Working Pressure (Mpa)	0.01-1			0.03-1				
Thermal Load (Heat Input-kW)	12/20kW			32kW				
Warranty	1 Year			1 Year				
Product Dimensions (in mm)		W	H	D		W	H	D
	06 Litres	300	445	120	16 Litres	410	680	223
	10 Litres	340	590	180				

Recommended for Kitchen & Bucket Bath

ERICA VERTICAL

(Manual)

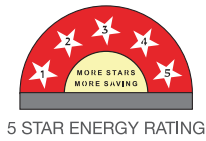

Available in 6/10/15/25 litres
The perfect storage water heater for small families

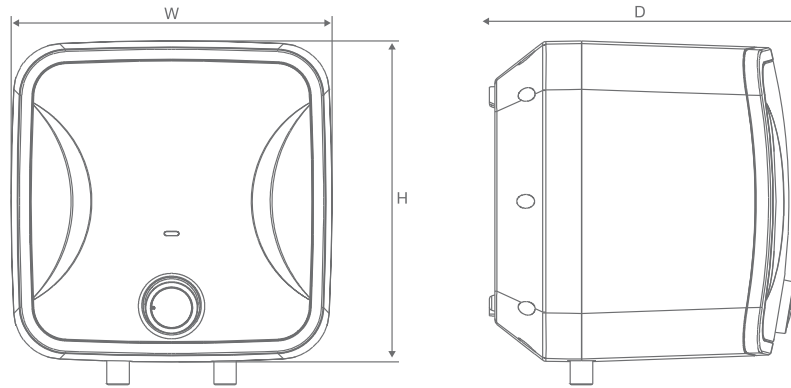

Product Specifications

Details	Erica Vertical (Manual)		
Volume (L)	6/10/15/25		
Rated Wattage	2 kW		
Voltage / Frequency (V/Hz)	230V/50Hz		
Temperature Range	25°C to 75°C		
Working Pressure (Mpa)	0.8		
Inlet / Outlet Connection (Inch)	1/2		
Warranty	7 Years on Tank 4 Years on Heating Element 2 Years on Other Parts		
Product Dimensions (in mm)	W	H	D
6 Litre	300	300	285
10 Litres	340	340	328
15 Litres	410	410	336
25 Litres	470	470	375

Recommended for: Kitchen / Bucket Baths / Overhead Showers

ERICA VERTICAL (Digital)

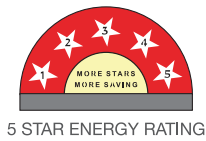

Available in 15/25 litres
The perfect storage water heater for small families

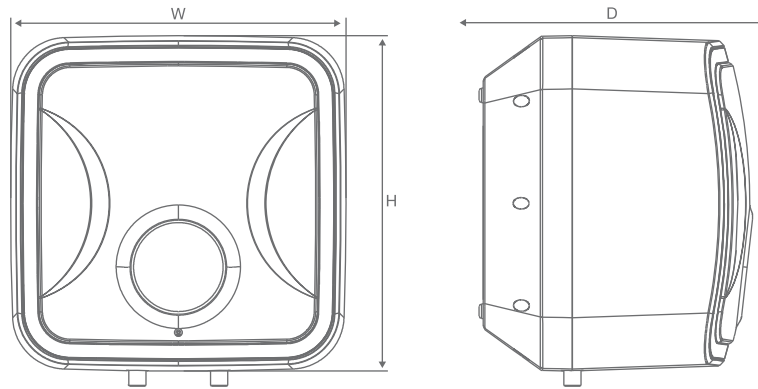

Product Specifications

Details	Erica Vertical (Digital)		
Volume (L)	15/25		
Rated Wattage	1+2 kW		
Voltage / Frequency (V/Hz)	230V/50Hz		
Temperature Range	25°C to 75°C		
Working Pressure (Mpa)	0.8		
Inlet / Outlet Connection (Inch)	1/2		
Warranty	7 Years on Tank 4 Years on Heating Element 2 Years on Other Parts		
Product Dimensions (in mm)	W	H	D
15 Litre	410	410	334
25 Litres	470	470	371

Recommended for: Kitchen / Bucket Baths / Overhead Showers

ELENA PRIME VERTICAL

(Manual)

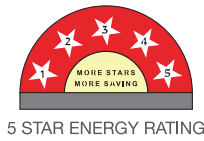

Available in 6/10/15/25 litres
The perfect storage water heater for small families

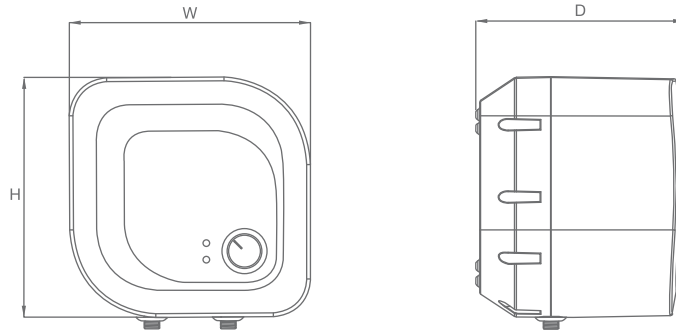

Product Specifications

Details	Elena Prime (Manual)		
Volume (L)	6/10/15/25		
Rated Wattage	2 kW		
Voltage / Frequency (V/Hz)	230V/50Hz		
Temperature Range	25°C to 75°C		
Working Pressure (Mpa)	0.8		
Inlet / Outlet Connection (Inch)	1/2		
Warranty	7 Years on Tank 4 Years on Heating Element 2 Years on Other Parts		
Product Dimensions (in mm)	W	H	D
6 Litre	316	316	273
10 Litres	366	366	285
15 Litres	402	402	312
25 Litres	452	452	369

Recommended for: Kitchen / Bucket Baths / Overhead Showers

ELENA VERTICAL

(Manual)



4 STAR ENERGY RATING



Available in 6/10/15/25 litres
The perfect storage water heater for small families

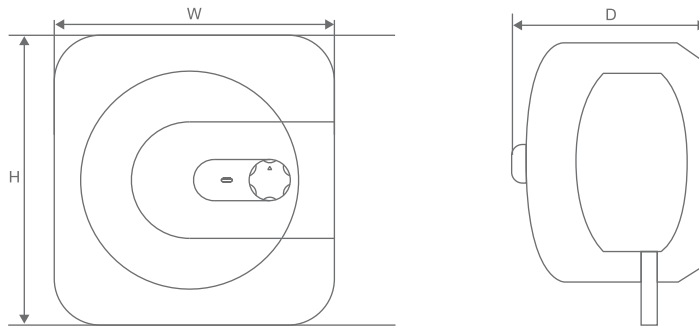

Product Specifications

Details	Elena Vertical (Manual)			
Volume (L)	6/10/15/25			
Rated Wattage	2kW			
Voltage / Frequency (V/Hz)	230V/50Hz			
Temperature Range	25°C to 75°C			
Working Pressure (Mpa)	0.8			
Inlet / Outlet Connection (Inch)	1/2			
Warranty	7 Years on Tank 4 Years on Heating Element 2 Years on Other Parts			
Product Dimensions (in mm)	W	H	D	
	6 Litres	288	288	260
	10 Litres	328	328	295
	15 Litres	385	385	305
	25 Litres	448	448	345

Recommended for: Kitchen / Bucket Baths / Overhead Showers

ELENA⁺

(Manual)

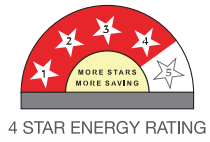

Available in 6/10 litres
The perfect instant storage water heater for small families

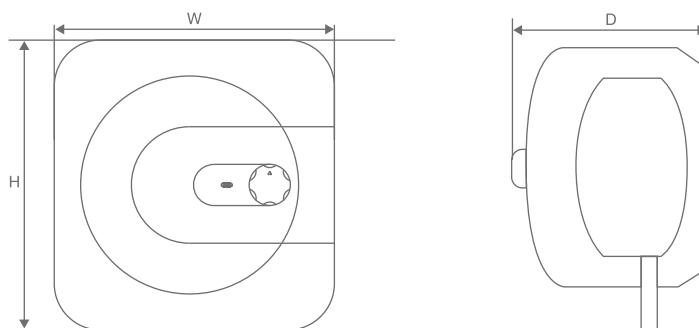

Product Specifications

Details	Elena ⁺ Vertical (Manual)			
Volume (L)	6/10			
Rated Wattage	3 kW			
Voltage / Frequency (V/Hz)	230V/50Hz			
Temperature Range	25°C to 75°C			
Working Pressure (Mpa)	0.8			
Inlet / Outlet Connection (Inch)	1/2			
Warranty	7 Years on Tank 4 Years on Heating Element 2 Years on Other Parts			
Product Dimensions (in mm)	W	H	D	
	6 Litres	288	288	260
	10 Litres	328	328	295

Recommended for: Kitchen / Bucket Baths / Overhead Showers

ELENA HORIZONTAL

(Manual)



3 STAR ENERGY RATING



Available in 15/25 litres
The perfect storage water heater for small families

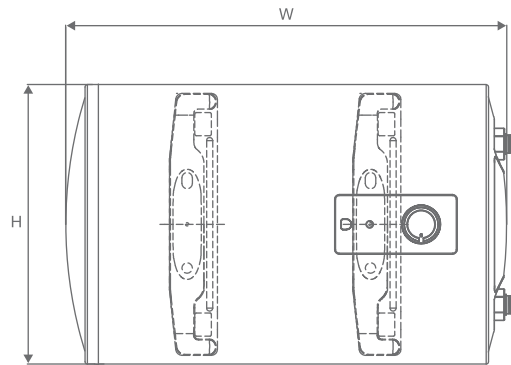

Product Specifications

Details	Elena Horizontal (Manual)	
Volume (L)	15/25	
Rated Wattage	2 kW	
Voltage / Frequency (V/Hz)	230V/50Hz	
Temperature Range	25°C to 75°C	
Working Pressure (Mpa)	0.8	
Inlet / Outlet Connection (Inch)	1/2	
Warranty	7 Years on Tank 4 Years on Heating Element 2 Years on Other Parts	
Product Dimensions (in mm)	W	H
	15 Litres	495
	25 Litres	747
		320

Available with Inlet / outlet on left hand side (LHS) and right hand side (RHS) Ideal for installation above false ceilings

ALEXA PLUS



2 STAR ENERGY RATING



Available in 20 litres
The perfect storage water heater for small families

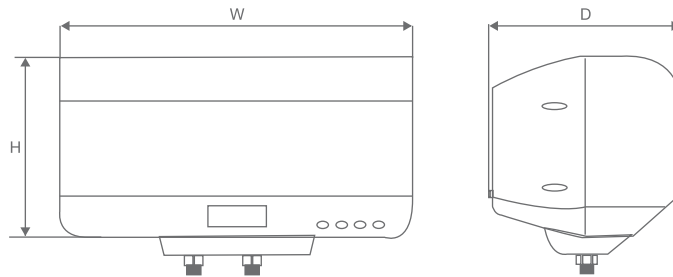

Product Specifications

Details	Alexa Plus Horizontal (Digital)		
Volume (L)	20		
Rated Wattage	2/3/5 kW		
Voltage / Frequency (V/Hz)	230V/50Hz		
Temperature Range	25°C to 75°C		
Working Pressure (Mpa)	0.8		
Inlet / Outlet Connection (Inch)	1/2		
Warranty	7 Years on Tank 4 Years on Heating Element 2 Years on Other Parts		
Product Dimensions (in mm)	W	H	D
	20 Litres	610	340
		320	

Recommended for Bucket Bath / Overhead Showers

ALEXA



2 STAR ENERGY RATING



Available in 30 litres
The perfect storage water heater for small families

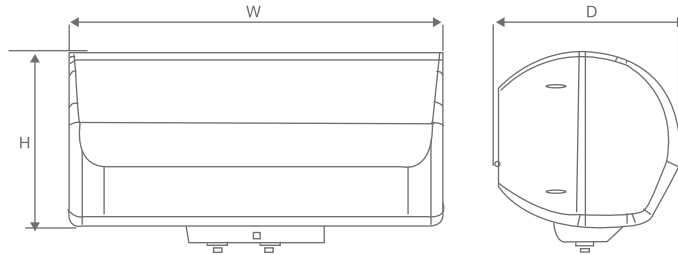

Product Specifications

Details	Alexa Horizontal (Digital)		
Volume (L)	30		
Rated Wattage	2/3/5kW		
Voltage / Frequency (V/Hz)	230V/50Hz		
Temperature Range	25°C to 75°C		
Working Pressure (Mpa)	0.8		
Inlet / Outlet Connection (Inch)	1/2		
Warranty	7 Years on Tank 4 Years on Heating Element 2 Years on Other Parts		
Product Dimensions (in mm)	W	H	D
	30 Litres	718	365 344

Recommended for Bucket Bath / Overhead Showers

VERSA VERTICAL

(Manual)



3 STAR ENERGY RATING



Available in 40/60/80/100 litres
For use with shower panels for bathtubs

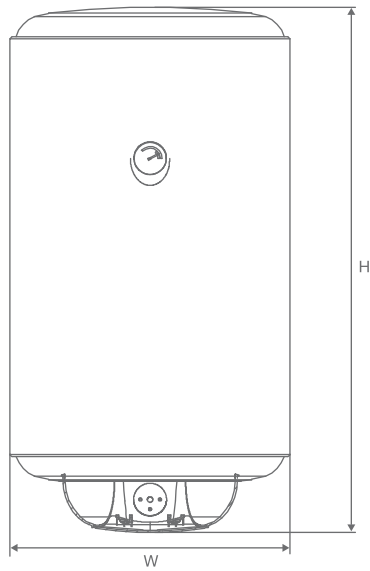

Product Specifications

Details	Versa Vertical (Manual)	
Volume (L)	40/60/80/100	
Rated Wattage	40/60 L - 2 kW 80/100 L - 3 kW	
Voltage / Frequency (V/Hz)	230V/50Hz	
Temperature Range	35°C to 75°C	
Working Pressure (Mpa)	0.8	
Inlet / Outlet Connection (Inch)	1/2	
Warranty	7 Years on Tank 4 Years on Heating Element 2 Years on Other Parts	
Product Dimensions (in mm)	W	H
	40 Litres	400 675
	60 Litres	400 900
	80 Litres	470 905
	100 Litres	470 1095

Recommended for: Overhead Showers / Shower Panels / Bathtubs

VERSA HORIZONTAL

(Manual)



3 STAR ENERGY RATING



Available in 40/60/80/100 litres
For use with shower panels for bathtubs

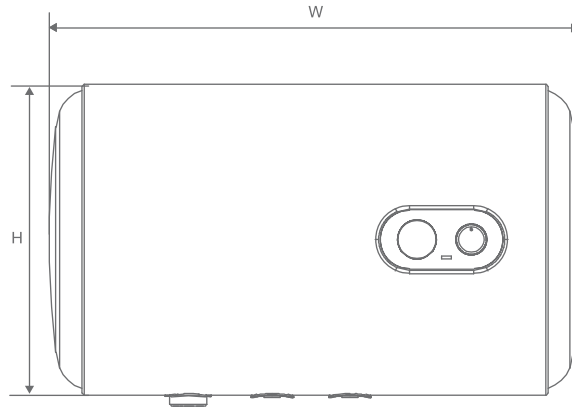

Product Specifications

Details	Versa Horizontal (Manual)		
Volume (L)	40/60/80/100		
Rated Wattage	40/60 L - 2 kW		
	80/100 L - 3 kW		
Voltage / Frequency (V/Hz)	230V/50Hz		
Temperature Range	35°C to 75°C		
Working Pressure (Mpa)	0.8		
Inlet / Outlet Connection (Inch)	1/2		
Warranty	7 Years on Tank		
	4 Years on Heating Element		
	2 Years on Other Parts		
Product Dimensions (in mm)		W	H
	40 Litres	685	400
	60 Litres	925	400
	80 Litres	895	470
	100 Litres	1065	470

Recommended for: Overhead Showers / Shower Panels / Bathtubs

VERSA HORIZONTAL

(Digital)



3 STAR ENERGY RATING



Available in 40/60/80/100 litres
For use with shower panels for bathtubs

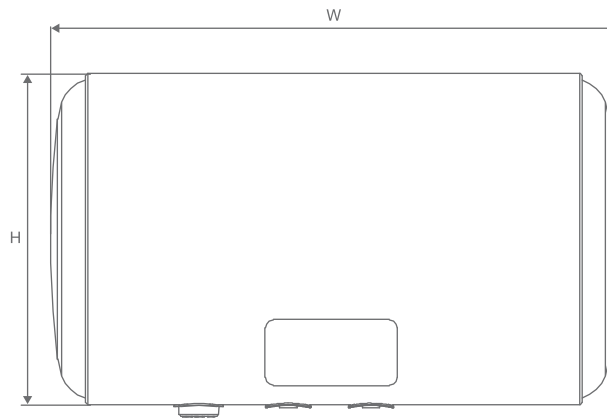

Product Specifications

Details	Versa Horizontal (Digital)	
Volume (L)	40/60/80/100	
Rated Wattage	1/2/3 kW	
Voltage / Frequency (V/Hz)	230V/50Hz	
Temperature Range	35°C to 75°C	
Working Pressure (Mpa)	0.8	
Inlet / Outlet Connection (Inch)	1/2	
Warranty	7 Years on Tank 4 Years on Heating Element 2 Years on Other Parts	
Product Dimensions (in mm)		
	W	H
40 Litres	685	400
60 Litres	925	400
80 Litres	895	470
100 Litres	1065	470

Recommended for: Overhead Showers / Shower Panels / Bathtubs

VERNA

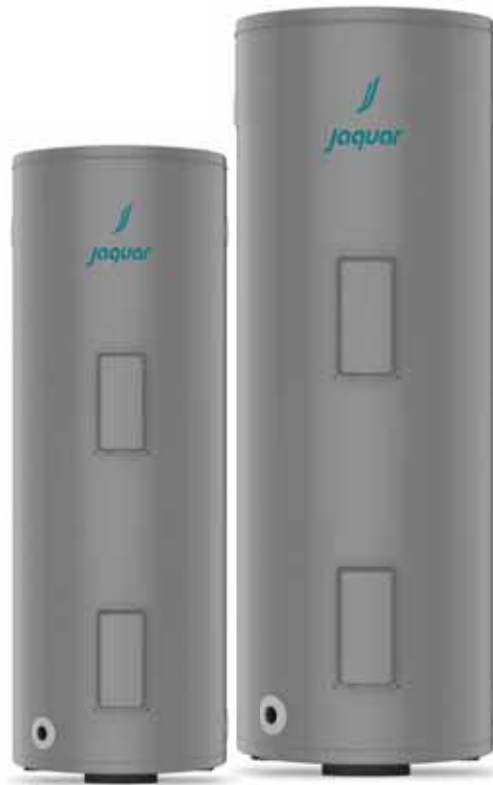

Available in 200/300/400/500 litres
For centralised hot water solutions

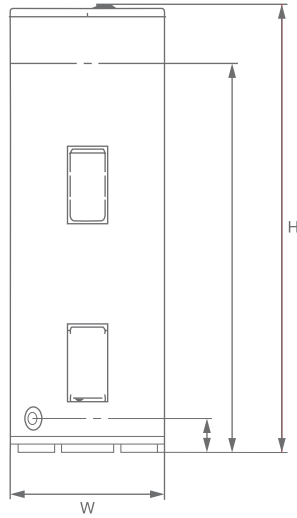

Product Specifications

Details	Verna Floor Mounted (Manual)		
Volume (L)	200/300/400/500		
Rated Wattage	200/300/400L - 2.5 kW x 2 500L - 3.00 kW x 2		
Voltage / Frequency (V/Hz)	230V/50Hz		
Temperature Range	35-75°C		
Working Pressure (Mpa)	1.0		
Inlet / Outlet Connection (Inch)	3/4		
Warranty	3 Years on Tank 3 Years on Heating Element 3 Years on Other Parts		
Product Dimensions (in mm)		W	H
	200 Litres	540	1575
	300 Litres	650	1600
	400 Litres	710	1650
	500 Litres	710	1999

Recommended as the Centralised Heating Solution for Multiple Bathrooms

INTEGRA

Monobloc Heat Pump



Available in 200/300 litres
For use in multiple bathrooms with
shower panels & bathtubs

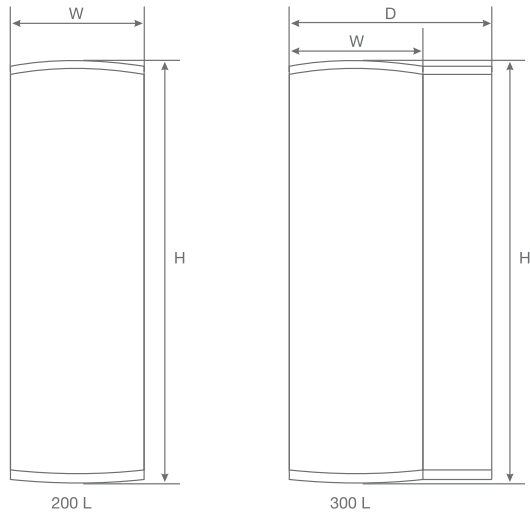

Product Specifications

Details	Integra Monobloc Heat Pump			
Tank Volume (L)	200/300			
Rated Heating Capacity (kW)	200L - 2.2			
	300L - 4.0			
Rated Input Power (kW)	200L - 0.55			
	300L - 0.99			
Working Ambient Temperature (Deg C)	-7 ~ 43			
Max Outlet Temperature (Deg C)	60/75			
Required Power Supply (V/Ph/Hz)	220/1/50			
Heating Element (kW)	2.0 kW			
Refrigerant Type	R134a			
Warranty	4 Years on Tank,			
	2 Years on heating element and compressor			
	1 Year on other components			
Net Dimension (mm)	W	H	D	
	200L	560	1980	--
	300L	560	1800	850
Weight - Net/ Gross (Kg)	200L	100	150	
	300L	130	180	

Recommended for: the Centralised Heating Solution for Multiple Bathrooms

INTEGRA

Split Heat Pump



Available in 300/400/500 litres
For use in multiple bathrooms with
shower panels & bathtubs

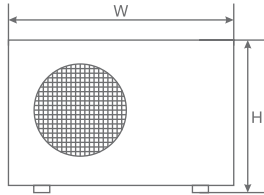

Heat Pump

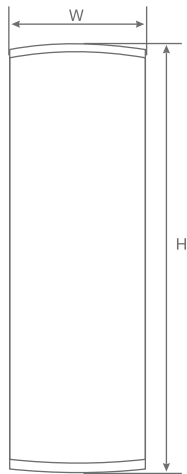

Water Tank

Product Specifications

Details	Integra Split Heat Pump			
Tank Volume (L)	300/400/500			
Rated Heating Capacity (kW)	300/400L - 5.2 500L - 7.2			
Rated Input Power (kW)	300/400L - 1.3 500L - 1.8			
Working Ambient Temperature (Deg C)	-7 ~ 43			
Max Outlet Temperature (Deg C)	60/75			
Required Power Supply (V/Ph/Hz)	220/1/50			
Heating Element (kW)	300L - 2.0 kW 400/500L - 4.0 kW			
Refrigerant Type	R410a			
Net Dimension - Heat Pump (mm)	W	H	D	
	300/400/500L	780	970	390
Net Dimension - Water Tank (mm)	W	H		
	300L	650	1427	
	400L	700	1480	
	500L	700	1850	
Warranty	4 Years on Tank, 2 Years on heating element and compressor 1 Year on other components			
Weight - Heat Pump - Net/Gross (Kg)	300/400L 48/65 500L 54/68			
Weight - Water Tank - Net/Gross (Kg)	300L 84/104 400L 105/125 500L 128/148			

Recommended for: the Centralised Heating Solution for Multiple Bathrooms

INTEGRA-X

Split Heat Pump



Available in 200/300/400/500 litres
For use in multiple bathrooms with
shower panels & bathtubs

Product Specifications

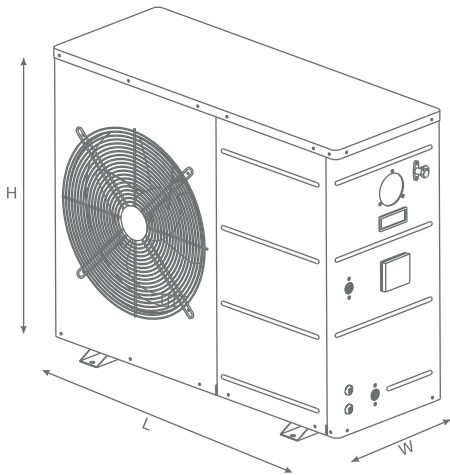
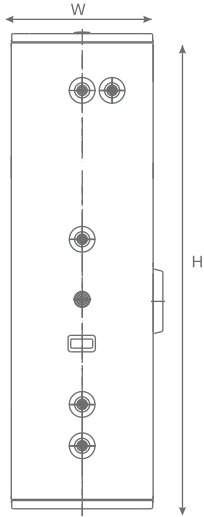

Details	Integra-X Split Heat Pump			
Tank Volume (L)	200/300/400/500			
Rated Heating Capacity (kW)	200 - 3.6/300L - 5.4			
	400 - 8.7/500L - 12.0			
Rated Input Power (kW)	200 - 0.87/300L - 1.3			
	400 - 2.15/500L - 2.95			
Working Ambient Temperature (Deg C)	-7 ~ 43			
Max Outlet Temperature (Deg C)	60/75			
Required Power Supply (V/Ph/Hz)	220/1/50			
Heating Element (kW)	200/300L - 3.0			
	400/500L - 4.0			
Refrigerant Type	R410a			
Net Dimension - Heat Pump (mm)		W	H	D
	200/300L	385	550	936
400/500L	420	800	986	
Net Dimension - Water Tank (mm)		W	H	
	200L	515	1730	
	300L	685	1360	
	400L	685	1740	
	500L	733	1820	
Warranty	4 Years on Tank,			
	3 Years on heating element and compressor			
	1 Year on other components			
Weight - Heat Pump - Net/Gross (Kg)	200L	55/59		
	300L	60/65		
	400L	80/87		
	500L	96/104		
Weight - Water Tank - Net/Gross (Kg)	200L	78/84		
	300L	88/95		
	400L	99/108		
	500L	126/136		

Recommended for: the Centralised Heating Solution for Multiple Bathrooms

JAQUAR GROUP

Global Headquarters,

Plot No. 3, Sector-11, IMT Manesar, Gurgaon-122050

E-mail: Sales: support@jaquar.com, Customer Service: service@jaquar.com

ORIENTATION CENTRES:

AHMEDABAD: Ground Floor, Commerce House-4, B/S Shell Petrol Pump, Near Anand Nagar Cross Roads, 100 Ft. Road, Prahlad Nagar, Satellite, Ahmedabad.

E-mail: ahmedabad@jaquar.com

BANGALORE: No. 10, V.N. Street, Next to Hotel Ramada, Shivaji Nagar, Tasker Town, Bangalore-560051.

Fax: 22862518.

E-mail: bangalore@jaquar.com

BHOPAL: Shop No. 7, 3rd Floor, City Center, Above Lotus, 1 Press Complex, M. P. Nagar, Zone-1, Bhopal-462011.

E-mail: bhopal@jaquar.com

BHUBANESWAR: Plot No. 853/1671, 2nd Floor, Jharpada, Cuttack Road, Bhubaneswar-751006.

E-mail: bhubaneswar@jaquar.com

CHANDIGARH: SCO-52, 53 Sector-17A, Opp. Park Plaza, Chandigarh-160022.

Fax: 2612755. E-mail:

chandigarh@jaquar.com

CHENNAI: Ground Floor, KGN Towers, 62 Ethiraj Salai, Chennai-600105.

Fax: 42144235. E-mail:

chennai@jaquar.com

COCHIN: No. 35/563, Opp. International Stadium, Palarivattom P.O., Cochin-682025. Fax: 2340887/88.

E-mail: cochin@jaquar.com

GUWAHATI: "Swagota Envision" Ground Floor, G.S.Road, Six-mile, Khanapara (Opp. Directorate Of Agriculture, Assam) Guwahati-781022

Email: guwahati@jaquar.com

HYDERABAD: Unit No. 202, Reliance Classic Banjara Hills, Road No.1, Hyderabad-500034. Fax: 23379595.

E-mail: hyderabad@jaquar.com

INDORE: 304 - 307, Darshan Mall, 15/2, Race Course Road, Above HSBC Bank, Indore.

E-mail: indore@jaquar.com

JAIPUR: Neelkanth, 1 Bhawani Singh Road, Opp. Nehru Sehkar Bhawan, C-Scheme, Jaipur-302 001.

E-mail: jaipur@jaquar.com

JAMMU: C/o Bonny Square, Near VISHAI Mega Mart, National Highway, Bypass Road, Kunjwani, Jammu, J&K - 180010.

E-mail: jammu@jaquar.com

KOLKATA: 2nd Floor, 55, Chowringhee Road, Kolkata-700071.

E-mail: kolkata@jaquar.com

LUCKNOW: Ground Floor, ASHA Bhawan, 27/II A, Gokhle Marg, Lucknow.

E-mail: lucknow@jaquar.com

LUDHIANA: 2nd Floor, Lodhi Complex, Mall Road, Ludhiana.

E-mail: ludhiana@jaquar.com

MUMBAI: 101, 102, 103, 1st Floor, Kamla Spaces, Above Kohinoor Electronics, S.V. Road, Near Khira Nagar, Santacruz (W), Mumbai-400 054. Fax: 26613917.

E-mail: mumbai@jaquar.com

NAGPUR: Kala Bhavan, 103/A South Ambazari Road, Shradhanand Peth Square, Laxminagar, Nagpur-440022

E-mail: nagpur@jaquar.com

NEW DELHI: D-56, Defence Colony, New Delhi-110 024. Fax: 24636809.

E-mail: delhincr@jaquar.com

PUNE: DSK Gandharva Heights, 5th Floor, Office No.501, Near Hotel Pride Executive, Ganeshkhind Road, Shivajinagar, Pune-411005. Fax: 25513921.

E-mail: pune@jaquar.com

RAIPUR: M.K. Planet, Ring Road No. 1, New Rajendra Nagar, Raipur-492001.

SILIGURI: 1st Floor, M-Square, Opp. Hotel Sachitra, 2nd Mile, Sevoke Road, Siliguri-734002.

E-mail: siliguri@jaquar.com

SURAT: 23, Siddhi Shopping Centre, Nr. Agrasen Bhavan Char Rasta, City Light Road, Surat.

E-mail: surat@jaquar.com

AREA REPRESENTATIVES:

AGRA: 9359150880

AKOLA: 9823352288

AMRITSAR: 9815379722

AURANGABAD: 8308838837

BARODA: 9825036745

BHAGALPUR: 7070997690

BILASPUR: 9779063131

CALICUT: 9895006320

COIMBATORE: 9884874121

DEHRADUN: 9837145508

DHANBAD: 9234682208

DHARAMSHALA: 9779063131

FARIDABAD: 7290003387

GOA: 09552521255, 08380096835, 07722043848

GURGAON: 9711361408

GUWAHATI: 9207049049, 0361-2463051

GWALIOR: 9993097335

HISSAR: 9779248104

JABALPUR: 9981530765

JALANDHAR: 9815914466

JODHPUR: 9829076309

JHANSI: 9839101081

KANPUR: 9839101081

KARNAL: 9779904793

KOLHAPUR: 7722034848

LUCKNOW: 8009211122

MEERUT: 8755984321

MORADABAD: 9897616491

MUZAFFARPUR: 7870025300

NAGPUR: 9823072050

NASIK: 07045347116, 09167395440

NOIDA: 9953070353

PATNA: 9835036635

RAIPUR: 9893049275, 9630095014

RAJKOT: 9825036746, 9825036743

RANCHI: 9709122225

ROHTAK: 9779248104

SHIMLA: 9779238123

SOLAPUR: 9881066275

UDAIPUR: 9829026309

U.P. (WEST): 9837065190

UTTRAKHAND KUMAON: 9690055888, 7055065558

VARANASI: 9935166968, 7570003576

KATHMANDU: 9851043149, 9741126044



1800-121-6808 (Toll Free)

* Add nearest Orientation Centre city code before the number.

Jaquar has an ongoing policy of design, development and improvement and thus reserves the right to modify specification and prices without any prior notice.



5 STAR ENERGY RATING
ON SELECTED MODELS



GAS | ELECTRIC | INSTANT | HEAT PUMP

Jaquar | WATER
HEATERS



www.jaquar.com

Follow us:

